

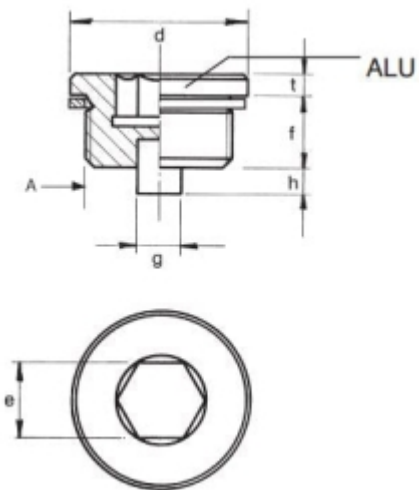

## AFTAPPLUG MET MAGNEET M30 X 2,0

Model: 7009-02-M30

### Omschrijving



#### Smeertechniek Rotterdam

Cairostraat 74  
3047 BC Rotterdam

T 010 - 466 62 55

F 010 - 466 66 55

E [info@smeertechniek.nl](mailto:info@smeertechniek.nl)

W [www.smeertechniek.nl](http://www.smeertechniek.nl)

Scan de QR code om  
dit product te bestellen





A	E	G	H	F	T	D	REF.
M10x1	5	5	4	8	3	14	7009-02-M10
M14x1,5	6	5	4	12	3	19	7009-02-M14
M16x1,5	8	5	4	12	3	21	7009-02-M16
M18x1,5	8	6	5	12	3	23	7009-02-M18
M20x1,5	10	6	5	14	4	25	7009-02-M20
M22x1,5	10	6	5	14	4	27	7009-02-M22
M24x2	12	6	5	14	4	29	7009-02-M24
M30x2	17	10	6	16	4	36	7009-02-M30
M33x2	17	10	6	16	5	40	7009-02-M33

**Smeertechniek Rotterdam**

Cairostraat 74  
3047 BC Rotterdam

T 010 - 466 62 55  
F 010 - 466 66 55  
E [info@smeertechniek.nl](mailto:info@smeertechniek.nl)  
W [www.smeertechniek.nl](http://www.smeertechniek.nl)

Scan de QR code om  
dit product te bestellen

